

COMM-MASTER

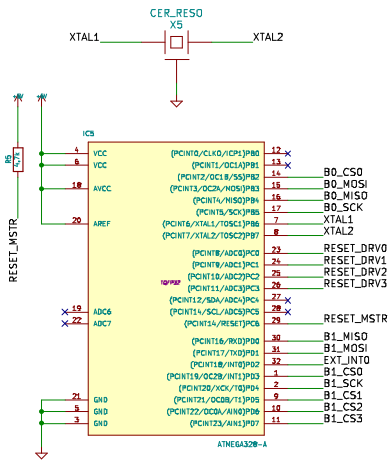

PANEL-TO-PANEL HEADERS

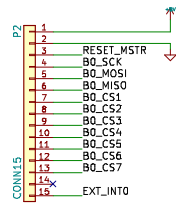

TOP HEADER

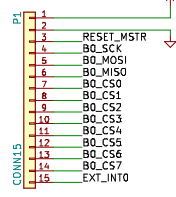

BOTTOM HEADER

BOARD-TO-BOARD CONNECTORS

PASS THRU SOCKET 3M9549-ND

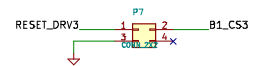
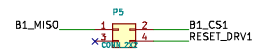
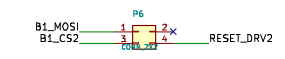
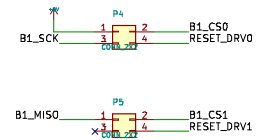

POWER FILTERING

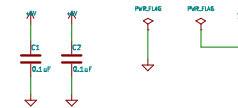

GND connector



Grounded mounting holes

